

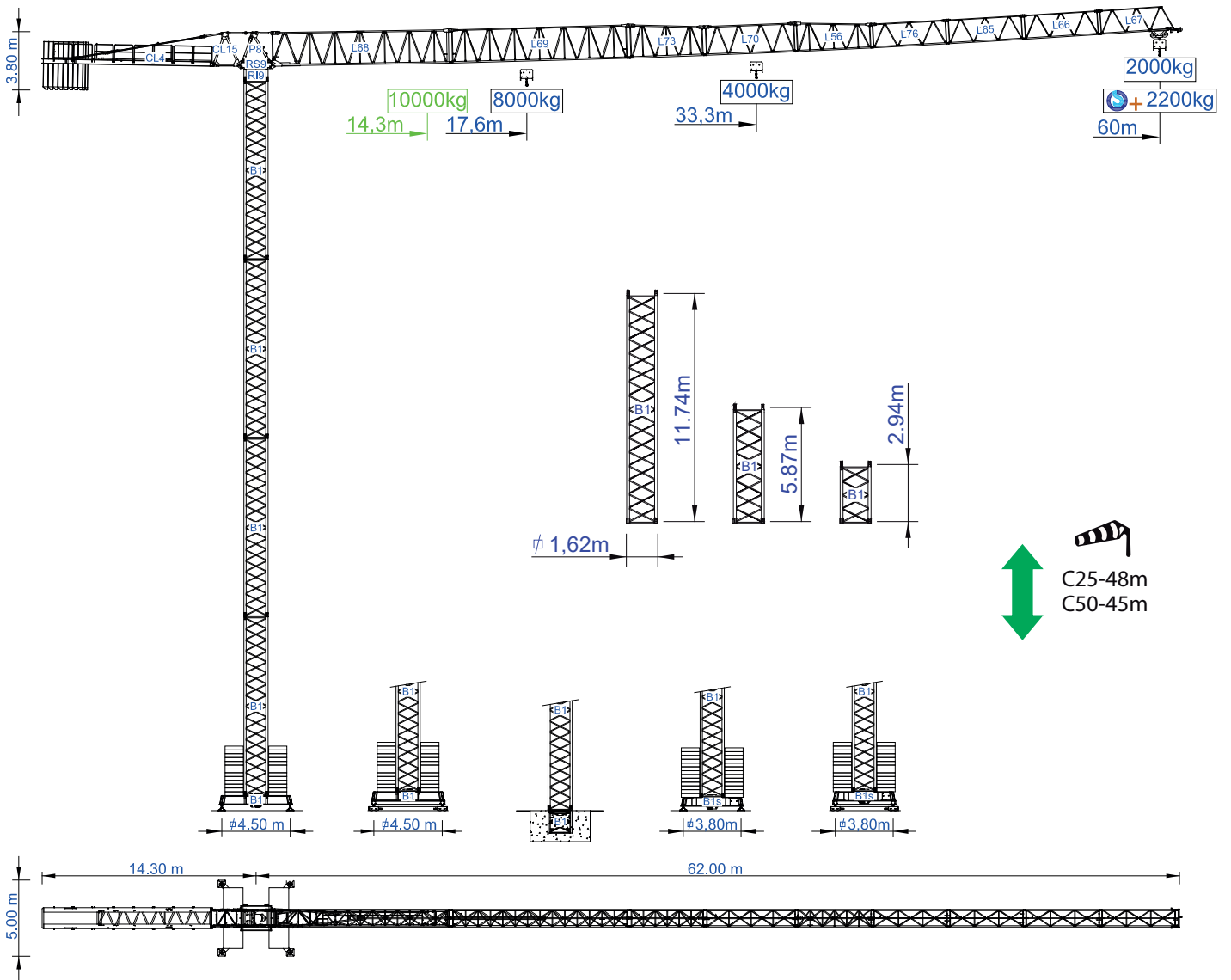

STAFFORD TOWER CRANES

STF 6020

Data Sheet / Catalogo / Fiche Technique / Scheda Dati
Dentenblatt / техническая спецификация
Metric / Métrico / Métrique / Metrico / Metrisch / метрика



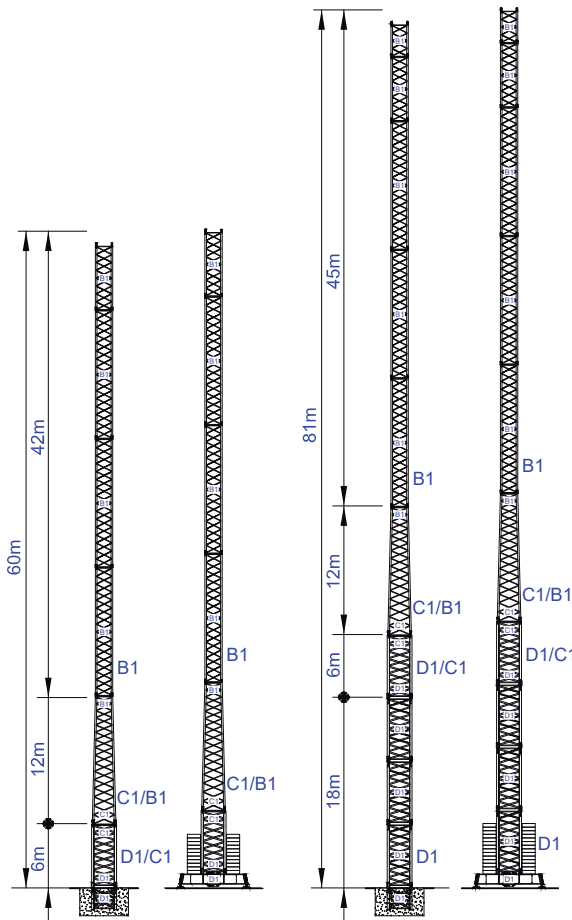
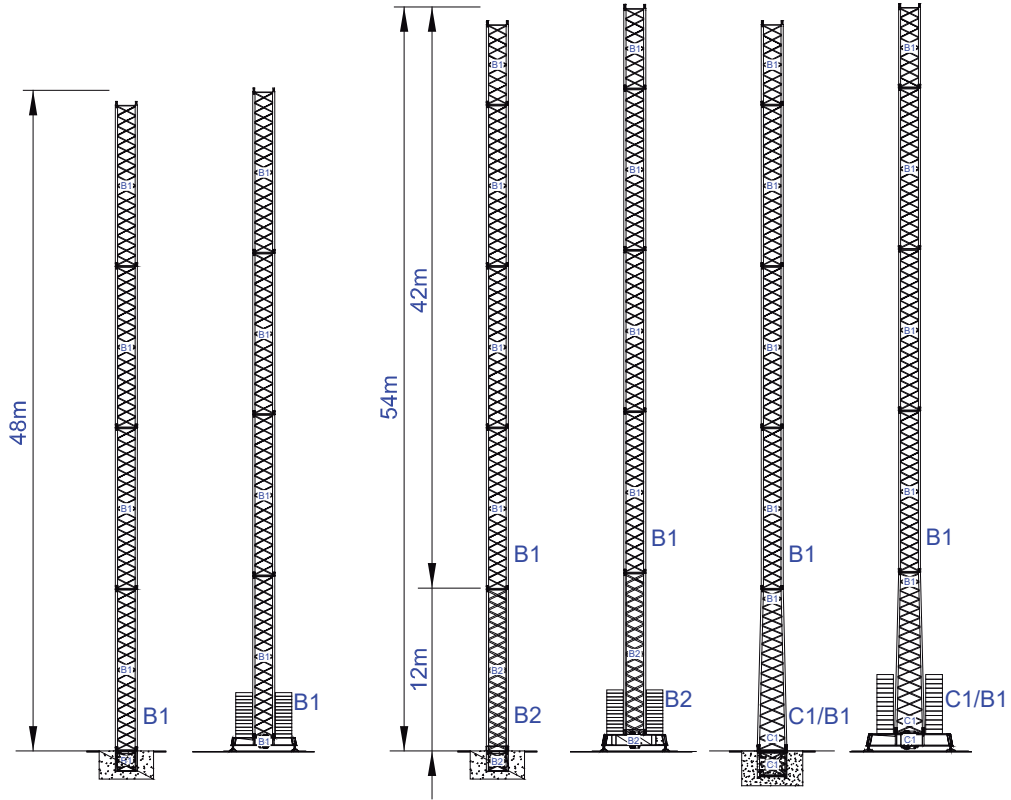

Empresa certificada no âmbito da Conceção, Fabrico e Serviço Pós-venda de Gruas Soima e componentes

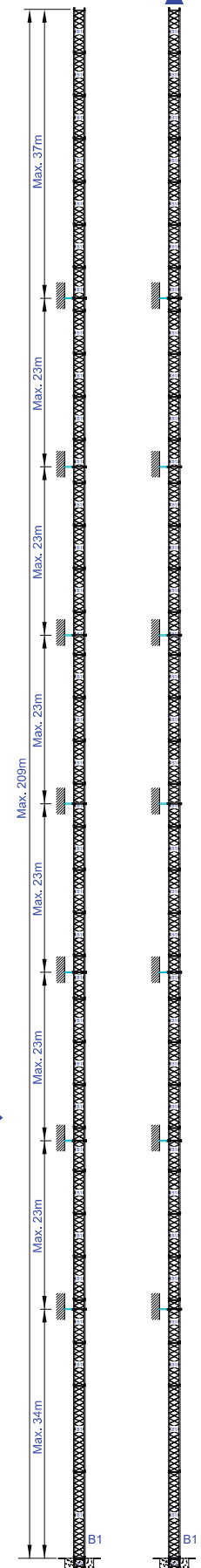
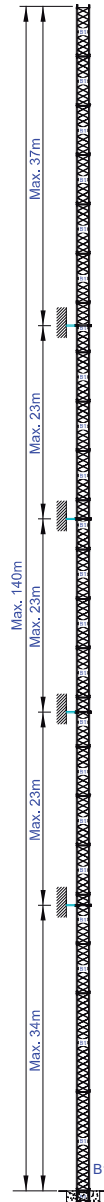
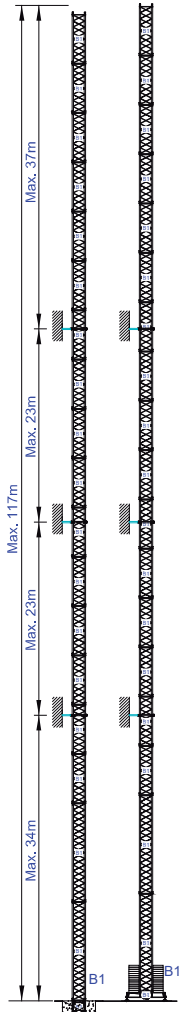
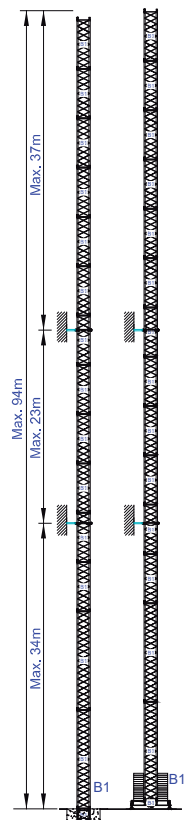
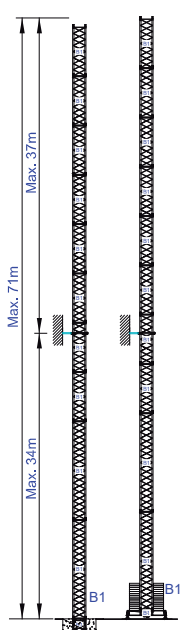
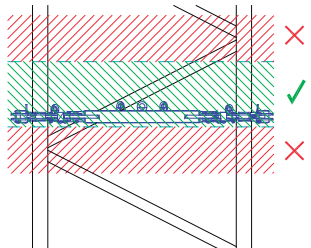
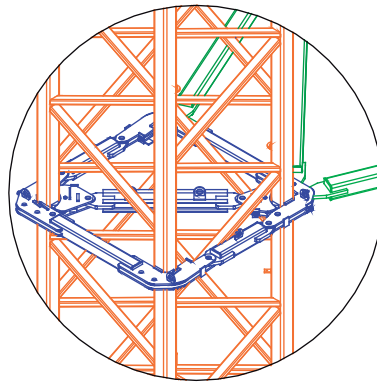

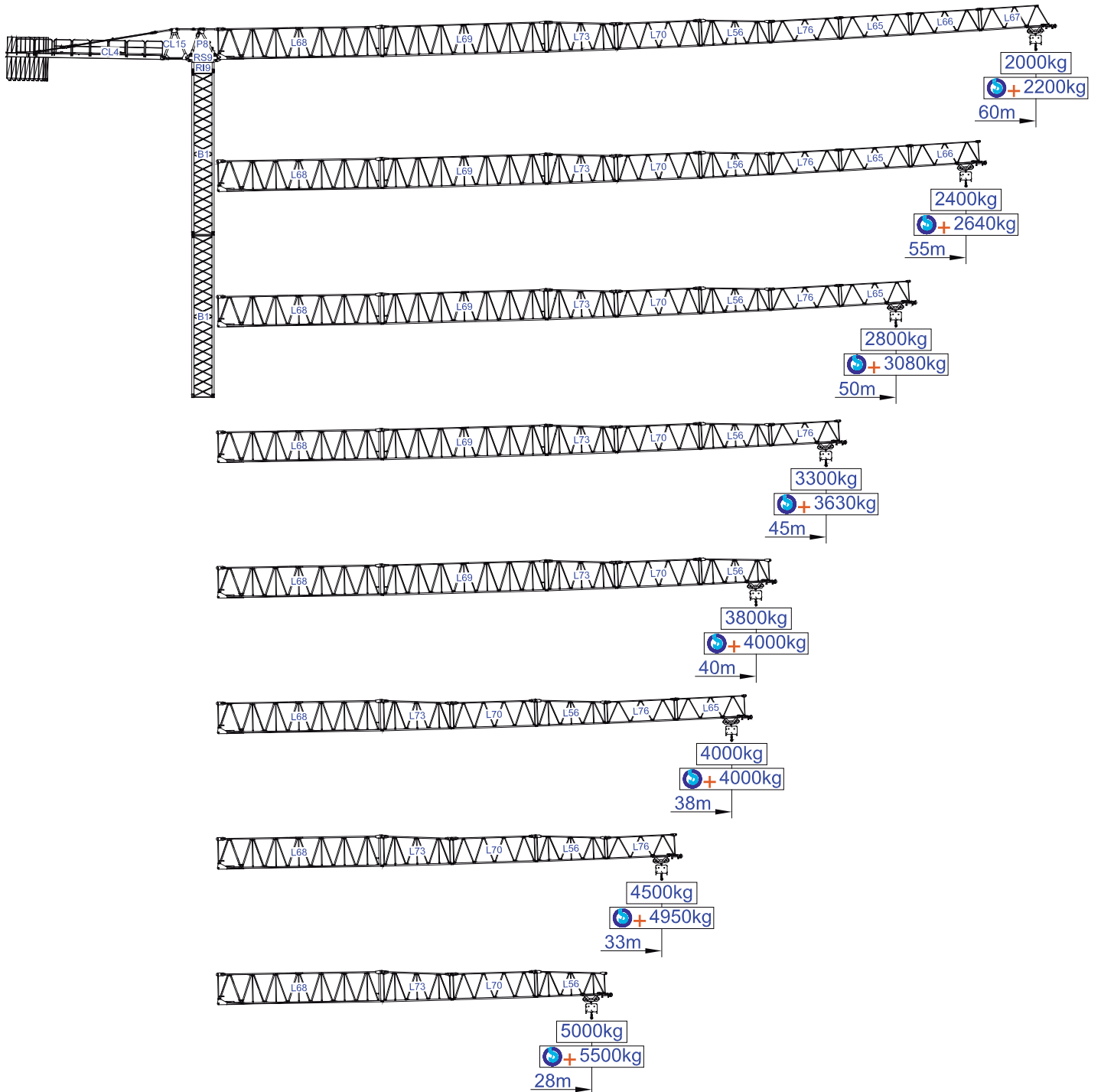





8000kg

m				10	15	18	23	28	33	38	40	45	50	55	60	m
		8000kg	4000kg													
60	18000kg 8x2000kg + 2x1000kg	17,6	33,3	4000	4000	4000	4000	4000	4000	3800	3580	3110	2750	2450	2200	kg
				8000	8000	8000	6620	5350	4460	3800	3580	3110	2750	2450	2200	
55	17000kg 8x2000kg + 1x1000kg	18,8	35,4	4000	4000	4000	4000	4000	4000	4000	3840	3340	2960	2640		
				8000	8000	8000	7070	5720	4760	4070	3840	3340	2960	2640		
50	17000kg 8x2000kg + 1x1000kg	19,4	36,7	4000	4000	4000	4000	4000	4000	4000	3990	3490	3080			
				8000	8000	8000	7340	5930	4950	4220	3990	3490	3080			
45	16000kg 7x2000kg + 2x1000kg	20,1	38,0	4000	4000	4000	4000	4000	4000	4000	4000	3630				
				8000	8000	8000	7623	6171	5148	4400	4158	3630				
40	15000kg 7x2000kg + 1x1000kg	20,2	38,2	4000	4000	4000	4000	4000	4000	4000	4000					
				8000	8000	8000	7680	6200	5180	4430	4180					
38	13000kg 6x2000kg + 1x1000kg	20,1	38,0	4000	4000	4000	4000	4000	4000							
				8000	8000	8000	7620	6170	5150		4400					
33	11000kg 5x2000kg + 1x1000kg	19,4	36,7	4000	4000	4000	4000	4000								
				8000	8000	8000	7340	5930		4950						
28	11000kg 5x2000kg + 1x1000kg	18,1	34,2	4000	4000	4000	4000									
				8000	8000	8000	6820		5500							
m																







10000kg

m				10	15	18	23	28	33	38	40	45	50	55	60	m
		10000kg	5000kg													
60	18000kg 8x2000kg + 2x1000kg	14,3	27,3	5000	5000	5000	5000	5000	4400	3740	3630	3080	2750	2420	2200	kg
				10000	10000	8580	6600	5390	4400	3740	3630	3080	2750	2420	2200	
55	17000kg 8x2000kg + 1x1000kg	15,2	29,0	5000	5000	5000	5000	5000	4730	4070	3850	3300	2970	2640		
				10000	10000	9240	7040	5720	4730	4070	3850	3300	2970	2640		
50	17000kg 8x2000kg + 1x1000kg	15,7	30,0	5000	5000	5000	5000	5000	4950	4180	3960	3520	3080			
				10000	10000	9570	7370	5940	4950	4180	3960	3520	3080			
45	16000kg 7x2000kg + 2x1000kg	16,3	31,1	5000	5000	5000	5000	5000	5170	4400	4180	3630				
				10000	10000	9900	7590	6160	5170	4400	4180	3630				
40	15000kg 7x2000kg + 1x1000kg	16,4	31,3	5000	5000	5000	5000	5000	5170	4400	4180					
				10000	10000	10010	7700	6160	5170	4400	4180					
38	13000kg 6x2000kg + 1x1000kg	16,3	31,1	5000	5000	5000	5000	5000	5170	4400						
				10000	10000	9900	7590	6160	5170	4400						
33	11000kg 5x2000kg + 1x1000kg	15,7	30,0	5000	5000	5000	5000	5000	4950							
				10000	10000	9570	7370	5940	4950							
28	11000kg 5x2000kg + 1x1000kg	14,7	28,0	5000	5000	5000	5000									
				10000	10000	8910	6820		5500							
m																





			A (mm)	B (mm)	C (mm)	kg(± 5%)
Jib / Lança / Fleche / Braccio		L68	11970	1900	2300	5050
/ Ausleger / кливер		L69	11960	1160	2260	1650
		L73	5230	1160	2260	750
		L70	6200	1160	1950	680
		L56	5200	1160	1930	590
		L76	5180	1160	1610	370
		L65	5110	1160	1610	330
		L66	5110	1160	1610	300
		L67	5110	1160	1610	290
Head turntable / Cabeçote / Pivot		RS9	2505	1700	1950	4650
/ Testa giradischi / Kopfplattenspieler		RI9	2505	1700	1950	4650
		P8	2230	1300	820	830
Counter-jib / Contra lança / Contre-fleche		CL15	1845	1220	2260	750
/ Gegenausleger / Контр-стрела		CL4	11400	1500	500	4000
Counterweight / Contrapeso / Contrepoids		CP2	1160	330	3140	8x2000 16000
/ Gegengewicht / Противовес		CP3	1160	165	3140	2x1000 2000
Tower section / torre / Coupe tour / Sezione torre		B1	12000	1620	1620	3450
/ Turmabschnitt / Секция башни		B1	6130	1620	1620	1800
		B1	3195	1620	1620	1070
Climbing tower section		B1	3195	1830	1830	1100
Foundation anchor / Tramo encastrar /		B1	1775	1600	1600	650
Base Chassis		B1	6620	500	1040	2190
			3120	340	1040	2x980 1960
TOTAL						4150
Base Chassis		B1s	5620	500	1040	1800
			2710	340	1040	2x900 1800
TOTAL						3600



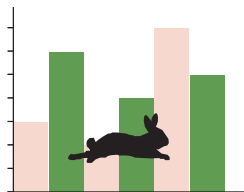

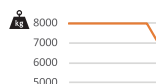
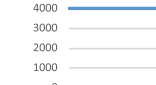

		
	0 a 1 r.p.m.	2x6,5 daN.m
	0 a 60 m/min	5,5 kW
	0-10 m/min	2x4 kW

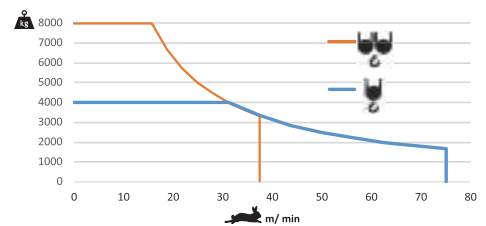



		
	0 a 75 m/min	22 kW
	0 a 37,5 m/min	



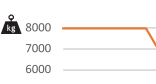
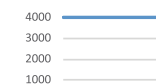

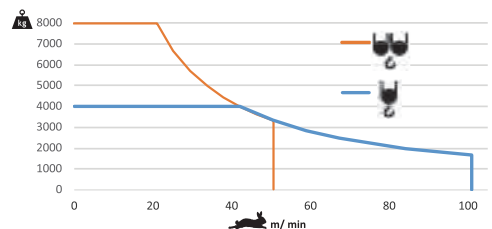
	48 kVA
	400 V +- 5% (50/60 Hz)

		
	0 a 94 m/min	30 kW
	0 a 47 m/min	



	58 kVA
	400 V +- 5% (50/60 Hz)

Max height of hoist

 (H)Max. 54m
 (H)Max. 108m + 



STF 6020

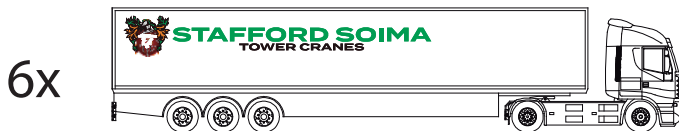
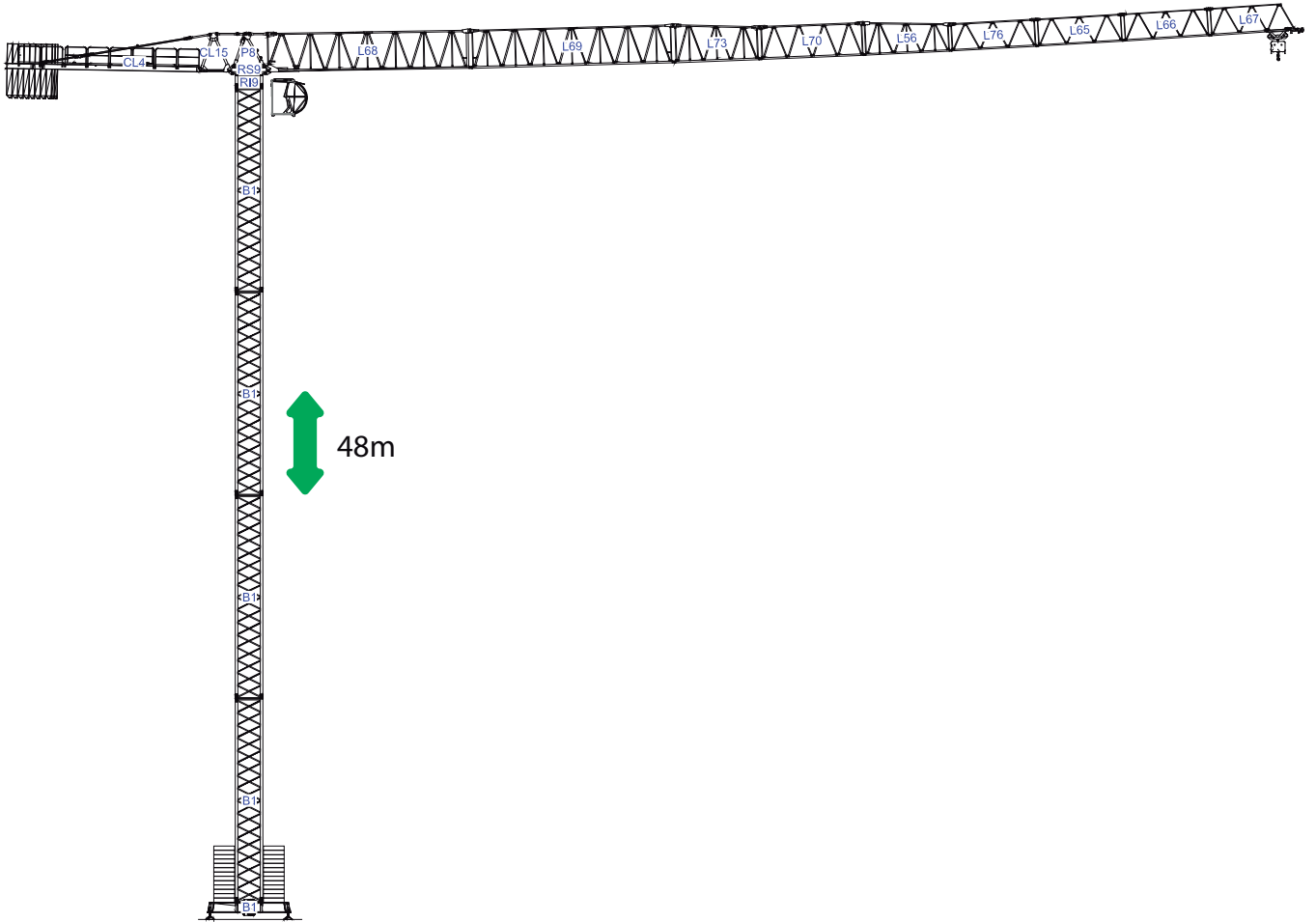

/

6x



40' High Cube



STF 6020

1

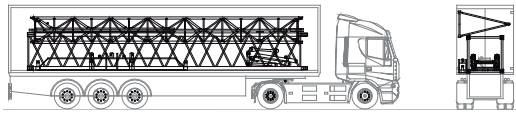

B1-L69-CH.B1-P8

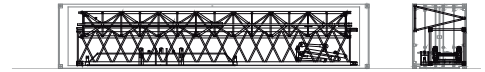

B1-L69-CH.B1-P8

2

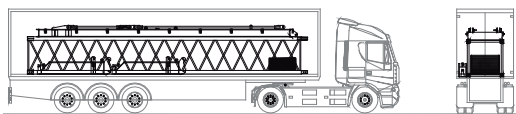

1xB1-CL4-2xCH.B1

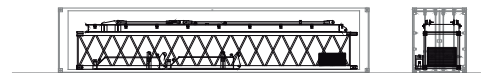

1xB1-CL4-2xCH.B1

3

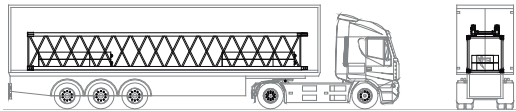

D1-4xCP2-CL15

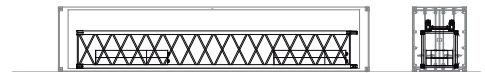

D1-4xCP2-CL15

4

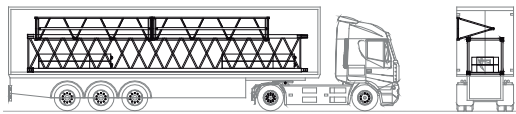

B1-L66-L67-4xCP2

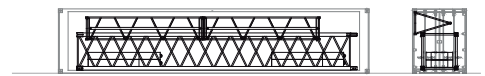

B1-L66-L67-4xCP2

5

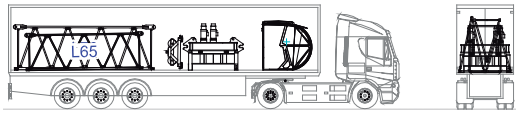

L70-L65-L76-CB1-RS9-RI9-TP1

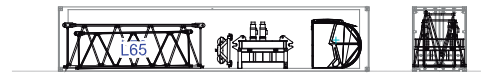

L70-L65-L76-CB1-RS9-RI9-TP1

6

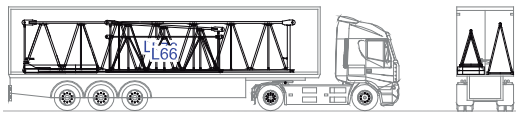

L68-L73-L56-2xCP3



L68-L73-L56-2xCP3



